

1



R I V E T T I
A S T R A P P O
B L I N D R I V E T S

RIVETTI A STRAPPO

BLIND RIVETS

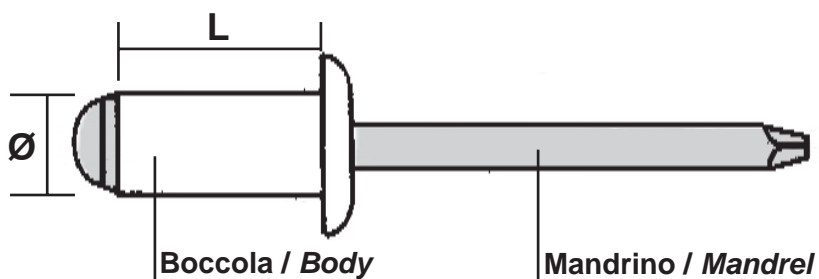

! Scelta del diametro del foro = \varnothing boccola + 0,1

! Choice of hole diameter = \varnothing body + 0,1

ESEMPIO / EXAMPLE

$\varnothing 4,8 + 0,1 = 4,9 \text{ mm.}$

!! Scelta della lunghezza del rivetto = spessore da serrare + \varnothing boccola

!! Choice of length of blind rivet = grip + \varnothing body

ESEMPIO / EXAMPLE

$4 \text{ mm.} + \varnothing 6 = 10 \text{ mm.}$

LEGENDA SIMBOL LIST

RIVETTI STANDARD STANDARD RIVETS

TT TESTA TONDA DOME HEAD 	TS TESTA SVASATA COUNTERSUNK HEAD 	TL TESTA LARGA LARGE HEAD 	TXL TESTA EXTRA LARGA EXTRA LARGE HEAD
---------------------------------	--	----------------------------------	---

RIVETTI A TENUTA STAGNA SEALED RIVETS

TST TT TESTA TONDA DOME HEAD 	TST TS TESTA SVASATA COUNTERSUNK HEAD
-------------------------------------	--

RIVETTI PER MATERIE PLASTICHE PEEL RIVETS

FA TT TESTA TONDA DOME HEAD 	SOF TT TESTA TONDA DOME HEAD
------------------------------------	-------------------------------------

RIVETTI MULTIFIX MULTIGRIP RIVETS

MX TT TESTA TONDA DOME HEAD 	MX TS TESTA SVASATA COUNTERSUNK HEAD 	MX TL TESTA LARGA LARGE HEAD
------------------------------------	---	-------------------------------------

RIVETTI RULLATI GROOVED RIVETS

RUL TT TESTA TONDA DOME HEAD

RIVETTI STRUTTURALI STRUCTURAL RIVETS

MFX TT TESTA TONDA DOME HEAD 	MFX TS TESTA SVASATA COUNTERSUNK HEAD 	MBX TT TESTA TONDA DOME HEAD
-------------------------------------	--	-------------------------------------

RIVETTI PER FOTOVOLTAICO PHOTOVOLTAIC RIVETS

SOF TTO TESTA TONDA DOME HEAD

INDICE DEI RIVETTI

INDEX OF RIVETS

1

2.34

CODICE CODE	DESCRIZIONE DESCRIPTION	PAGINA PAGE
AL-TT	ALLUMINIO-ACCIAIO TESTA TONDA / ALUMINIUM-STEEL DOME HEAD	3-4
AL-TS	ALLUMINIO-ACCIAIO TESTA SVASATA / ALUMINIUM-STEEL CSK HEAD	5
AL-TL	ALLUMINIO-ACCIAIO TESTA LARGA / ALUMINIUM-STEEL LARGE HEAD	6
AL-TXL	ALLUMINIO-ACCIAIO TESTA EXTRA LARGA / ALUMINIUM-STEEL EXTRA L. HEAD	6
ALAL-TT	ALLUMINIO-ALLUMINIO TESTA TONDA / ALUMINIUM-ALUMINIUM DOME HEAD	7
ALX-TT	ALLUMINIO-INOX TESTA TONDA / ALUMINIUM-STAINLESS STEEL DOME HEAD	8
AOZ-TT	ACCIAIO-ACCIAIO TESTA TONDA / STEEL-STEEL DOME HEAD	9
AOZ-TS	ACCIAIO-ACCIAIO TESTA SVASATA / STEEL-STEEL CSK HEAD	10
TUX-TT	CUPRO NICHEL-INOX TESTA TONDA / COPPER NICKEL-A2 DOME HEAD	11
IX-A2-TT	INOX-INOX TESTA TONDA / A2 - A2 DOME HEAD	12
IX-A2-TS	INOX-INOX TESTA SVASATA / A2 - A2 CSK HEAD	12
IX-A2-TL	INOX-INOX TESTA LARGA / A2 - A2 LARGE HEAD	13
IX-A2-TXL	INOX-INOX TESTA EXTRA LARGA / A2 - A2 EXTRA LARGE HEAD	13
IX-A4-TT	INOX A4-INOX A4 TESTA TONDA / A4 - A4 DOME HEAD	14
CU-TT	RAME-ACCIAIO TESTA TONDA / COPPER-STEEL DOME HEAD	15
CUO-TT	RAME-OTTONE TESTA TONDA / COPPER-BRAS DOME HEAD	16
AL-RUL-TT	ALLUMINIO-ACCIAIO TESTA TONDA / ALUMINIUM-STEEL DOME HEAD	17
FA-TT	ALLUMINIO-ACCIAIO TESTA TONDA / ALUMINIUM-STEEL DOME HEAD	17
AL-SOF-TT	ALLUMINIO-ALLUMINIO TESTA TONDA / ALUM.-ALUM. DOME HEAD	18
AL-SOF-TTO	ALLUMINIO-ALLUMINIO TESTA TONDA / ALUM.-ALUM. DOME HEAD	18
TST-AL-TT	ALLUMINIO-ACCIAIO TESTA TONDA / ALUMINIUM-STEEL DOME HEAD	19
TST-AL-TS	ALLUMINIO-ACCIAIO TESTA SVASATA / ALUMINIUM-STEEL CSK HEAD	19
TST-ALX-TT	ALLUMINIO-INOX TESTA TONDA / ALUMINIUM-A2 DOME HEAD	20
TST-AOZ-TT	ACCIAIO-ACCIAIO TESTA TONDA / STEEL-STEEL DOME HEAD	20
TST-CU-TT	RAME-ACCIAIO TESTA TONDA / COPPER-STEEL DOME HEAD	21
TST-CUX-TT	RAME-INOX TESTA TONDA / COPPER-A2 DOME HEAD	21
TST-IX-TT	INOX-INOX TESTA TONDA / A2-A2 DOME HEAD	22
MX-AL-TT	ALLUMINIO-ACCIAIO TESTA TONDA / ALUMINIUM-STEEL DOME HEAD	23
MX-AL-TS	ALLUMINIO-ACCIAIO TESTA SVASATA / ALUMINIUM-STEEL CSK HEAD	23
MX-AL-TL	ALLUMINIO-ACCIAIO TESTA LARGA / ALUMINIUM-STEEL LARGE HEAD	24
MX-AL-TXL	ALLUMINIO-ACCIAIO TESTA EXTRA LARGA / ALUMINIUM-STEEL EXTRA L	24
MX-ALX-TT	ALLUMINIO-INOX TESTA TONDA / ALUMINIUM-A2 DOME HEAD	25
MX-AOZ-TT	ACCIAIO-ACCIAIO TESTA TONDA / STEEL-STEEL DOME HEAD	25
MFX-TT	ACCIAIO-ACCIAIO TESTA TONDA / STEEL-STEEL DOME HEAD	26
MFX-TS	ACCIAIO-ACCIAIO TESTA SVASATA / STEEL-STEEL CSK HEAD	26
MFX-TT-AL	ALLUMINIO-ALLUMINIO TESTA TONDA / ALUM.-ALUM. DOME HEAD	27
MFX-TS-AL	ALLUMINIO-ALLUMINIO TESTA SVASATA / ALUM.-ALUM. CSK HEAD	27
MFX-TT-IX	INOX-INOX TESTA TONDA / A2 - A2 DOME HEAD	28
MFX-TS-IX	INOX-INOX TESTA SVASATA / A2 - A2 DOME HEAD	28
MBX-TT	ACCIAIO-ACCIAIO TESTA TONDA / STEEL-STEEL DOME HEAD	29
MBX-TT-IX	INOX-INOX TESTA TONDA / A2 - A2 DOME HEAD	30
150	RIVETTATRICE MANUALE / HAND TOOL	31
260	RIVETTATRICE MANUALE / HAND TOOL	31
RI144BB	RIVETTATRICE A BATTERIA / BLIND RIVETS SETTING TOOL	32
AP 1-2-3	RIVETTATRICI PNEUMATICHE / PNEUMATIC TOOLS	33
BZ 103	RIVETTATRICE PNEUMATICA / PNEUMATIC TOOL	34
BZ 123	RIVETTATRICE PNEUMATICA / PNEUMATIC TOOL	34

RIVETTI A STRAPPO STANDARD

STANDARD BLIND RIVETS

AL - TT

TESTA TONDA
DOME HEAD

boccola / *body*

alluminio / *aluminium*

mandrino / *mandrel*

acciaio zincato / *steel zinc plated*

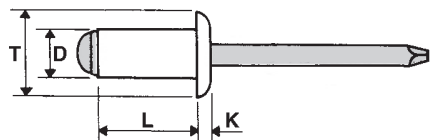

RIVETTI VERNICIATI A RICHIESTA

PAINTED RIVETS ON REQUEST



D	L	T	K	∅ foro/hole		CODICE code		
2,4	4	5	0,7	2,5	0,5 - 2	AL2404TT	800 N	500 N
	5				0,5 - 2,5	AL2405TT		
	6				2,5 - 4	AL2406TT		
	8				4 - 6	AL2408TT		
	10				6 - 8	AL2410TT		
	12				8 - 10	AL2412TT		
3,0	4	6	0,8	3,1	0,5 - 1,5	AL3004TT	900 N	550 N
	5				0,5 - 2	AL3005TT		
	6				1 - 3	AL3006TT		
	7				2 - 4	AL3007TT		
	8				3 - 5	AL3008TT		
	9				4 - 6	AL3009TT		
	10				5 - 7	AL3010TT		
	11				6 - 8	AL3011TT		
	12				7 - 9	AL3012TT		
	14				9 - 11	AL3014TT		
	16				11 - 13	AL3016TT		
	18				13 - 15	AL3018TT		
	20				15 - 17	AL3020TT		
	3,2				5	6,5		
6		1 - 3	AL3206TT					
7		2 - 4	AL3207TT					
8		3 - 5	AL3208TT					
9		4 - 6	AL3209TT					
10		5 - 7	AL3210TT					
11		6 - 8	AL3211TT					
12		7 - 9	AL3212TT					
14		9 - 11	AL3214TT					
16		11 - 13	AL3216TT					
18		13 - 15	AL3218TT					
20		14 - 17	AL3220TT					
25		17 - 22	AL3225TT					
3,4		5	7	0,8	3,5		0,5 - 2	AL3405TT
	7	2 - 4				AL3407TT		
	9	4 - 6				AL3409TT		
	11	6 - 8				AL3411TT		
	14	9 - 11				AL3414TT		
	16	11 - 13				AL3416TT		
18	13 - 15	AL3418TT						
4,0	5	8	1,0	4,1	0,5 - 1,5	AL4005TT	2050 N	1300 N
	6				1 - 2,5	AL4006TT		
	7				2 - 3,5	AL4007TT		
	8				3 - 4,5	AL4008TT		
	9				4 - 5,5	AL4009TT		
	10				5 - 6,5	AL4010TT		
	11				6 - 7,5	AL4011TT		
	12				7 - 8,5	AL4012TT		
	14				8 - 10,5	AL4014TT		
	16				10 - 12,5	AL4016TT		
	18				12 - 14,5	AL4018TT		
	20				14 - 16,5	AL4020TT		
	22				16 - 18,5	AL4022TT		
	24				18 - 20,5	AL4024TT		
	26				20 - 22,5	AL4026TT		
	28				22 - 24,5	AL4028TT		
	30				24 - 26,5	AL4030TT		
	35				27 - 31,5	AL4035TT		

RIVETTI A STRAPPO STANDARD

STANDARD BLIND RIVETS

1

4.34

D	L	T	K	∅ foro/hole		CODICE code		
4,8	6	10	1,1	5,0	0,5 - 2	AL4806TT	2800	2050
	7				1,5 - 3	AL4807TT		
	8				2,5 - 4	AL4808TT		
	9				3,5 - 5	AL4809TT		
	10				4,5 - 6	AL4810TT		
	11				5,5 - 7	AL4811TT		
	12				6,5 - 8	AL4812TT		
	14				7,5 - 10	AL4814TT		
	16				9,5 - 12	AL4816TT		
	18				11,5 - 14	AL4818TT		
	20				13,5 - 16	AL4820TT		
	22				15,5 - 18	AL4822TT		
	24				17,5 - 20	AL4824TT		
	26				19,5 - 22	AL4826TT		
	28				21,5 - 24	AL4828TT		
	30				23,5 - 26	AL4830TT		
	35				25,5 - 28	AL4835TT		
	40				30,5 - 36	AL4840TT		
	45				35,5 - 40	AL4845TT		
	50				39,5 - 45	AL4850TT		
55	45 - 50	AL4855TT						
60	50 - 55	AL4860TT						
65	55 - 60	AL4865TT						
70	60 - 65	AL4870TT						
6,0	8	12	1,5	6,1	2 - 4	AL6008TT	4350	3200
	10				2,5 - 5	AL6010TT		
	12				4,5 - 7	AL6012TT		
	14				5,5 - 9	AL6014TT		
	16				6,5 - 10	AL6016TT		
	18				9,5 - 13	AL6018TT		
	20				11 - 14	AL6020TT		
	22				12,5 - 17	AL6022TT		
	26				16,5 - 21	AL6026TT		
	30				20,5 - 25	AL6030TT		
	35				24,5 - 30	AL6035TT		
	40				29,5 - 35	AL6040TT		
6,4	10	13	1,8	6,6	2,5 - 5	AL6410TT	5100	3250
	12				4,5 - 7	AL6412TT		
	16				6,5 - 10	AL6416TT		
	18				9,5 - 13	AL6418TT		
	22				12,5 - 17	AL6422TT		
	26				16,5 - 21	AL6426TT		
	30				20,5 - 25	AL6430TT		
	35				24,5 - 30	AL6435TT		
40	29,5 - 35	AL6440TT						

AL - TT

TESTA TONDA
DOME HEAD

boccola / body

alluminio / aluminium

mandrino / mandrel

acciaio zincato / steel zinc plated

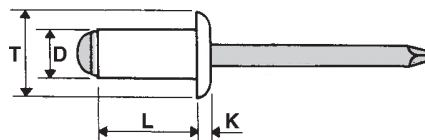

RIVETTI VERNICIATI A RICHIESTA
PAINTED RIVETS ON REQUEST

RIVETTIA STRAPPO STANDARD

STANDARD BLIND RIVETS

AL - TS

TESTA SVASATA
COUNTERSUNK HEAD

boccola / *body*

alluminio / *aluminium*

mandrino / *mandrel*

acciaio zincato / *steel zinc plated*

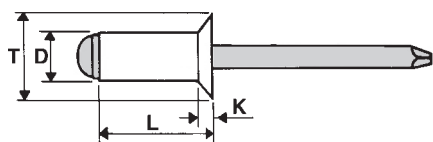





D	L	T	K	∅ foro/hole		CODICE code		
2,4	6	5	-	2,5		AL2406TS AL2408TS AL2410TS	900 N	500 N
	8							
	10							
3,0	6	6	-	3,1		AL3006TS AL3007TS AL3008TS AL3009TS AL3010TS AL3011TS AL3012TS AL3014TS	900 N	550 N
	7							
	8							
	9							
	10							
	11							
	12							
14								
3,2	6	6,5	-	3,3		AL3206TS AL3207TS AL3208TS AL3209TS AL3210TS AL3211TS AL3212TS AL3214TS AL3216TS	1100 N	800 N
	7							
	8							
	9							
	10							
	11							
	12							
	14							
16								
4,0	6	8	-	4,1		AL4006TS AL4007TS AL4008TS AL4009TS AL4010TS AL4011TS AL4012TS AL4014TS AL4016TS AL4018TS AL4020TS	2050 N	1300 N
	7							
	8							
	9							
	10							
	11							
	12							
	14							
	16							
	18							
	20							
4,8	7	10	-	5		AL4807TS AL4808TS AL4809TS AL4810TS AL4811TS AL4812TS AL4814TS AL4816TS AL4818TS AL4820TS AL4826TS AL4830TS AL4835TS	2800 N	2050 N
	8							
	9							
	10							
	11							
	12							
	14							
	16							
	18							
	20							
	26							
	30							
	35							

RIVETTI A STRAPPO STANDARD

STANDARD BLIND RIVETS

1

6.34

D	L	T	K	∅ foro/hole		CODICE code		
3,2	6	10	2	3,3		AL3206TL	1100 N	800 N
	8					AL3208TL		
	10					AL3210TL		
	12					AL3212TL		
	14					AL3214TL		
	16					AL3216TL		
4,0	6	10	2,5	4,1		AL4006TL	2050 N	1300 N
	8					AL4008TL		
	10					AL4010TL		
	12					AL4012TL		
	14					AL4014TL		
	16					AL4016TL		
	20					AL4020TL		
	4,8					8		
10		AL4810TL						
12		AL4812TL						
14		AL4814TL						
16		AL4816TL						
18		AL4818TL						
20		AL4820TL						
24		AL4824TL						
26		AL4826TL						
30		AL4830TL						
35		AL4835TL						
40		AL4840TL						



AL - TL

TESTA LARGA
LARGE HEAD

boccola / *body*
alluminio / aluminium

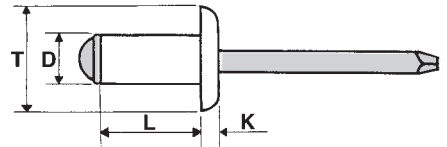
mandrino / *mandrel*
acciaio zincato / steel zinc plated



4,0	8	12	2	4,1		AL4008TXL	2050 N	1300 N
	10					AL4010TXL		
	12					AL4012TXL		
	14					AL4014TXL		
	16					AL4016TXL		
	20					AL4020TXL		
4,8	8	16	2,5	5,0		AL4808TXL	2800 N	2050 N
	10					AL4810TXL		
	12					AL4812TXL		
	14					AL4814TXL		
	16					AL4816TXL		
	18					AL4818TXL		
	20					AL4820TXL		
	24					AL4824TXL		
	26					AL4826TXL		
	30					AL4830TXL		
	35					AL4835TXL		
	40					AL4840TXL		

AL - TXL

TESTA EXTRA LARGA
EXTRA LARGE HEAD

boccola / *body*
alluminio / aluminium

mandrino / *mandrel*
acciaio zincato / steel zinc plated

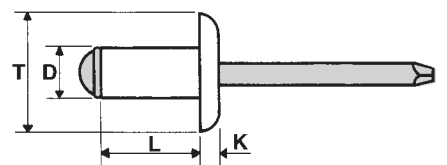

RIVETTI A STRAPPO STANDARD

STANDARD BLIND RIVETS

ALAL - TT

TESTA TONDA
DOME HEAD

boccola / body

alluminio / aluminium

mandrino / mandrel

alluminio / aluminium

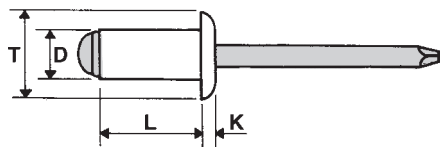



D	L	T	K	∅ foro/hole		CODICE code									
3,2	6	6,5	0,8	3,3		1,5 - 3,5	670	540							
	8					3,5 - 5									
	10					5 - 7									
	12					7 - 8,5									
	14					8,5 - 10,5									
	16					10,5 - 13									
4,0	6	8	1,0	4,1		1,5 - 3,5	1020	850							
	8					3,5 - 5									
	10					5 - 6,5									
	12					6,5 - 8,5									
	14					8,5 - 10,5									
	16					10,5 - 12,5									
	18					12,5 - 14,5									
	20					14,5 - 16,5									
	4,8					8			9,5	1,1	5,0		3 - 4,5	1400	1150
						10							4,5 - 6		
12		6 - 7,5													
14		7,5 - 9													
16		9 - 11,5													
18		11,5 - 13													
20		13 - 15													
25		15 - 20													
30		20 - 25													

RIVETTI A STRAPPO STANDARD

STANDARD BLIND RIVETS

1

8.34

D	L	T	K	∅ foro/hole		CODICE code		
3,0	6	6	0,8	3,1	1 - 3	ALX3006TT	950 N	750 N
	8				3 - 5	ALX3008TT		
	10				5 - 7	ALX3010TT		
	12				7 - 9	ALX3012TT		
	14				9 - 11	ALX3014TT		
3,2	6	6,5	0,8	3,3	1 - 3	ALX3206TT	1200 N	750 N
	8				3 - 5	ALX3208TT		
	10				5 - 7	ALX3210TT		
	12				7 - 9	ALX3212TT		
4,0	6	8	1,0	4,1	1 - 2,5	ALX4006TT	2150 N	1300 N
	8				3 - 4,5	ALX4008TT		
	10				5 - 6,5	ALX4010TT		
	12				7 - 8,5	ALX4012TT		
	14				8 - 10,5	ALX4014TT		
	16				10 - 12,5	ALX4016TT		
	20				14 - 16,5	ALX4020TT		
4,8	6	10	1,1	5,0	0,5 - 2	ALX4806TT	2500 N	2100 N
	8				2,5 - 4	ALX4808TT		
	10				4,5 - 6	ALX4810TT		
	12				6,5 - 8	ALX4812TT		
	14				7,5 - 10	ALX4814TT		
	16				9,5 - 12	ALX4816TT		
	18				11,5 - 14	ALX4818TT		
	20				13,5 - 16	ALX4820TT		
	26				19,5 - 22	ALX4826TT		
	30				23,5 - 26	ALX4830TT		

ALX - TT

TESTA TONDA
DOME HEAD

boccola / body
alluminio / aluminium

mandrino / mandrel
**acciaio inox A2 / stainless
steel A2**

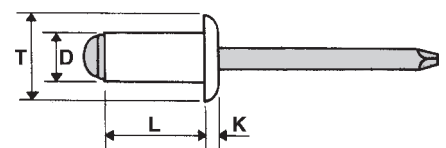

RIVETTI A STRAPPO STANDARD

STANDARD BLIND RIVETS

AOZ - TT

TESTA TONDA
DOME HEAD

boccola / body

acciaio zincato / steel zinc plated

mandrino / mandrel

acciaio zincato / steel zinc plated

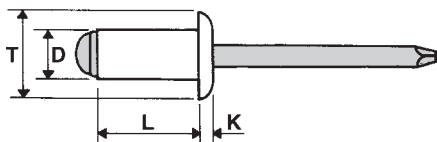







D	L	T	K	∅ foro/hole		CODICE code									
3,0	5	6	0,8	3,1		0,5 - 1,5	1300 N	950 N							
	6					AOZ3005TT									
	7					AOZ3006TT									
	8					AOZ3007TT									
	9					AOZ3008TT									
	10					AOZ3009TT									
	11					AOZ3010TT									
	12					AOZ3011TT									
3,2	6	6,5	0,8	3,3		0,5 - 3	1500 N	1000 N							
	7					AOZ3206TT									
	8					AOZ3207TT									
	9					AOZ3208TT									
	10					AOZ3209TT									
	11					AOZ3210TT									
	12					AOZ3211TT									
	14					AOZ3212TT									
4,0	6	8	1,0	4,1		0,5 - 2,5	2350 N	1800 N							
	7					AOZ4006TT									
	8					AOZ4007TT									
	9					AOZ4008TT									
	10					AOZ4009TT									
	11					AOZ4010TT									
	12					AOZ4011TT									
	14					AOZ4012TT									
	16					AOZ4014TT									
	18					AOZ4016TT									
	20					AOZ4018TT									
	24					AOZ4020TT									
30	AOZ4024TT														
4,8	6	9	1,1	5		0,5 - 2	3900 N	3050 N							
	7					AOZ4806TT									
	8					AOZ4807TT									
	9					AOZ4808TT									
	10					AOZ4809TT									
	11					AOZ4810TT									
	12					AOZ4811TT									
	14					AOZ4812TT									
	16					AOZ4814TT									
	18					AOZ4816TT									
	20					AOZ4818TT									
	24					AOZ4820TT									
	26					AOZ4824TT									
	30					AOZ4826TT									
	6,0					10			12	1,5	6,1		3 - 4	5450 N	4250 N
						12							AOZ6010TT		
15		AOZ6012TT													
18		AOZ6015TT													
22		AOZ6018TT													
30		AOZ6022TT													
6,4	12	12	1,8	6,6		3,5 - 7	6800 N	5250 N							
	15					AOZ6412TT									
	18					AOZ6415TT									
	22					AOZ6418TT									
	26					AOZ6422TT									
	30					AOZ6426TT									

RIVETTI A STRAPPO STANDARD

STANDARD BLIND RIVETS

1

10.34

D	L	T	K	∅ foro/hole		CODICE code		
3,0	6	6	-	3,1		1,5 - 3	1125 N	950 N
	8					AOZ3006TS		
	10					AOZ3008TS		
	12					AOZ3010TS		
	12					AOZ3012TS		
3,2	6	6,5	-	3,3		1,5 - 3	1500 N	1000 N
	8					AOZ3206TS		
	10					AOZ3208TS		
	12					AOZ3210TS		
	12					AOZ3212TS		
	14					AOZ3214TS		
4,0	6	8	-	4,1		1,5 - 2,5	2350 N	1800 N
	8					AOZ4006TS		
	10					AOZ4008TS		
	12					AOZ4010TS		
	12					AOZ4012TS		
	14					AOZ4014TS		
	16					AOZ4016TS		
4,8	8	10	-	5,0		1,5 - 4	3900 N	3050 N
	10					AOZ4808TS		
	12					AOZ4810TS		
	14					AOZ4812TS		
	16					AOZ4814TS		
	16					AOZ4816TS		
	20					AOZ4820TS		
	22					AOZ4822TS		

AOZ - TS

TESTA SVASATA
COUNTERSUNK HEAD

boccola / body

acciaio zincato / steel zinc plated

mandrino / mandrel

acciaio zincato / steel zinc plated

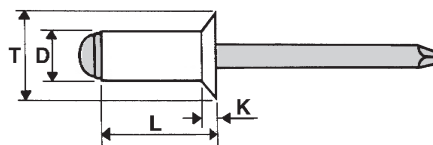

RIVETTI A STRAPPO STANDARD

STANDARD BLIND RIVETS

12.34

1

D	L	T	K	∅ foro/hole		CODICE code		
3,0	6	6,5	0,8	3,1	1,5 - 2,5	IXA23006TT	2000 N	1600 N
	8				2,5 - 4,5	IXA23008TT		
	10				4,5 - 6,5	IXA23010TT		
	12				6,5 - 8,5	IXA23012TT		
3,2	6	6,5	0,8	3,3	1,5 - 2,5	IXA23206TT	2500 N	1800 N
	8				2,5 - 4,5	IXA23208TT		
	10				4,5 - 6,5	IXA23210TT		
	12				6,5 - 8,5	IXA23212TT		
	14				8,5 - 12	IXA23215TT		
4,0	6	8	1,0	4,1	1 - 2	IXA24006TT	3800 N	3100 N
	8				2 - 4	IXA24008TT		
	10				4 - 6	IXA24010TT		
	12				6 - 8	IXA24012TT		
	14				8 - 10	IXA24014TT		
	16				10 - 12,5	IXA24016TT		
	18				12 - 14	IXA24018TT		
20	14 - 16	IXA24020TT						
4,8	8	9,5	1,1	5,0	1,5 - 3	IXA24808TT	6000 N	4500 N
	10				3 - 5	IXA24810TT		
	12				5 - 7	IXA24812TT		
	14				7 - 9	IXA24814TT		
	16				9 - 11	IXA24816TT		
	18				11 - 13	IXA24818TT		
	20				13 - 15	IXA24820TT		
	22				15 - 17	IXA24823TT		
	25				17 - 20	IXA24825TT		
	30				20 - 25	IXA24830TT		
6,0	10	12	1,5	6,1	2 - 4	IXA26010TT	8800 N	6500 N
	12				4 - 6	IXA26012TT		
	15				6 - 9	IXA26015TT		
	18				9 - 12	IXA26018TT		
	20				12 - 14	IXA26020TT		
6,4	10	13	1,8	6,5	2 - 4	IXA26410TT	8800 N	6500 N
	12				2,5 - 4,5	IXA26412TT		
	15				6 - 9	IXA26415TT		
	18				9 - 13	IXA26418TT		
	20				13 - 16	IXA26420TT		
	25				16 - 20	IXA26425TT		
3,2	6	6	-	3,3	1,5 - 2,5	IXA23206TS	2500 N	1800 N
	8				2,5 - 4,5	IXA23208TS		
	10				4,5 - 6,5	IXA23210TS		
	12				6,5 - 8,5	IXA23212TS		
4,0	6	7,5	-	4,1	1 - 2	IXA24006TS	3800 N	3100 N
	8				2 - 4	IXA24008TS		
	10				4 - 6	IXA24010TS		
	12				6 - 8	IXA24012TS		
	14				8 - 10	IXA24014TS		
	16				10 - 12	IXA24016TS		
4,8	8	9	-	4,9	1,5 - 3	IXA24808TS	6000 N	4500 N
	10				3 - 5	IXA24810TS		
	12				5 - 7	IXA24812TS		
	16				9 - 11	IXA24815TS		
	18				11 - 13	IXA24818TS		
	20				13 - 15	IXA24821TS		

IX-A2 - TT

TESTA TONDA DOME HEAD

boccola / body

acciaio inox A2 / stainless steel A2

mandrino / mandrel

acciaio inox A2 / stainless steel A2

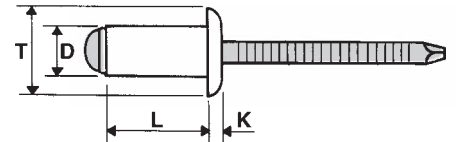

IX-A2 - TS

TESTA SVASATA COUNTERSUNK HEAD

boccola / body

acciaio inox A2 / stainless steel A2

mandrino / mandrel

acciaio inox A2 / stainless steel A2

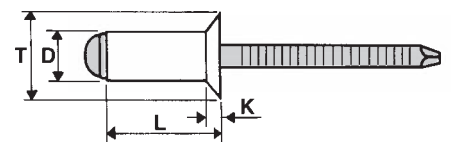

RIVETTI A STRAPPO STANDARD

STANDARD BLIND RIVETS

IX-A2 - TL

TESTA LARGA LARGE HEAD

boccola / body

acciaio inox A2 / stainless steel A2

mandrino / mandrel

acciaio inox A2 / stainless steel A2

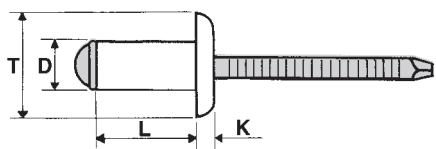

D	L	T	K	∅ foro/hole		CODICE code			
3,2	6	9,5	1,3	3,3		IXA23206TL	2300 N	1800 N	
	8					1,5 - 2,5			IXA23208TL
	10					2,5 - 4,5			IXA23210TL
	12					4,5 - 6,5			IXA23212TL
	14					6,5 - 8,5			IXA23214TL
4,0	6	12	1,6	4,1		IXA24006TL	3600 N	2800 N	
	8					1 - 2			IXA24008TL
	10					2 - 4			IXA24010TL
	12					4 - 6			IXA24012TL
	14					6 - 8			IXA24014TL
	16					8 - 10			IXA24016TL
4,8	8	14	1,8	4,9		IXA24808TL	5300 N	4200 N	
	10					1,5 - 3			IXA24810TL
	12					3 - 5			IXA24812TL
	14					5 - 7			IXA24814TL
	16					7 - 9			IXA24816TL
	18					9 - 11			IXA24818TL
	20					11 - 13			IXA24820TL
	20					13 - 15			IXA24820TL

IX-A2 - TXL

TESTA EXTRA LARGA EXTRA LARGE HEAD

boccola / body

acciaio inox A2 / stainless steel A2

mandrino / mandrel

acciaio inox A2 / stainless steel A2

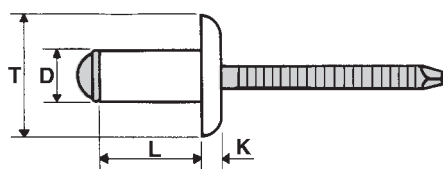







4,8	8	16	1,8	4,9		IXA24808TXL	5300 N	4200 N	
	10					1,5 - 3			IXA24810TXL
	12					3 - 5			IXA24812TXL
	14					5 - 7			IXA24814TXL
	16					7 - 9			IXA24816TXL
	18					9 - 11			IXA24818TXL
	20					11 - 13			IXA24818TXL
	22					13 - 15			IXA24820TXL
	25					16 - 18			IXA24822TXL
	30					18 - 20			IXA24825TXL
	30					20 - 25			IXA24830TXL

RIVETTI A STRAPPO STANDARD

STANDARD BLIND RIVETS

1

14.34

D	L	T	K	∅ foro/hole		CODICE code		
3,0	6	6,5	0,8	3,1		IXA43006TT	2000 N	1600 N
	8					IXA43008TT		
	10					IXA43010TT		
3,2	6	6,5	0,8	3,3		IXA43206TT	2500 N	1800 N
	8					IXA43208TT		
	10					IXA43210TT		
	12					IXA43212TT		
	14					IXA43214TT		
	16					IXA43216TT		
4,0	6	8,0	1,0	4,1		IXA44006TT	3800 N	3100 N
	8					IXA44008TT		
	10					IXA44010TT		
	12					IXA44012TT		
	14					IXA44014TT		
	16					IXA44016TT		
4,8	8	9,5	1,1	4,9		IXA44808TT	6000 N	4500 N
	10					IXA44810TT		
	12					IXA44812TT		
	14					IXA44814TT		
	16					IXA44816TT		
	18					IXA44818TT		

IX-A4 - TT

TESTA TONDA
DOME HEAD

boccola / body
acciaio inox A4 / stainless steel A4

mandrino / mandrel
acciaio inox A4 / stainless steel A4

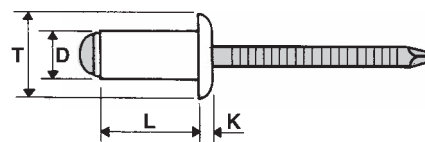

RIVETTI A STRAPPO STANDARD

STANDARD BLIND RIVETS

CU - TT

TESTA TONDA
DOME HEAD

boccola / *body*
rame / *copper*

mandrino / *mandrel*
acciaio zincato / *steel zinc plated*

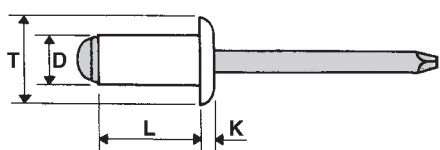





D	L	T	K	∅ foro/hole		CODICE code		
3,0	5	6	0,8	3,1		CU3005TT CU3006TT CU3007TT CU3009TT CU3011TT CU3012TT	950 N	650 N
	6							
	7							
	9							
	11							
	12							
3,2	6	6,5	0,8	3,3		CU3206TT CU3207TT CU3209TT CU3211TT CU3212TT	950 N	650 N
	7							
	9							
	11							
	12							
	12							
3,4	7	7	0,8	3,5		CU3407TT CU3409TT CU3411TT CU3412TT CU3414TT	1100 N	800 N
	9							
	11							
	12							
	12							
	14							
4,0	6	8	1,0	4,1		CU4006TT CU4007TT CU4009TT CU4011TT CU4012TT CU4014TT CU4016TT	1900 N	1300 N
	7							
	9							
	11							
	12							
	14							
4,8	8	9,5	1,1	5,0		CU4808TT CU4810TT CU4812TT CU4814TT CU4816TT CU4818TT CU4820TT	2000 N	1500 N
	10							
	12							
	14							
	16							
	18							
	20							
	20							

RIVETTI A STRAPPO STANDARD

STANDARD BLIND RIVETS

1

16.34

D	L	T	K	∅ foro/hole		CODICE code		
3,2	6	6,5	0,8	3,3		1 - 3	1200 N	900 N
	7					2 - 4		
	9					4 - 6		
	11					6 - 8		
	12					7 - 9		
3,4	7	7	0,8	3,5		2 - 4	1400 N	1000 N
	9					4 - 6		
	11					6 - 8		
	12					7 - 9		
	14					9 - 11		
	4,0					6		
7		2 - 3,5						
9		4 - 5,5						
11		6 - 7,5						
12		7 - 8,5						
14		8 - 10,5						
16		10 - 12,5						

CUO - TT

TESTA TONDA
DOME HEAD

boccola / *body*
rame / *copper*

mandrino / *mandrel*
ottone / *brass*

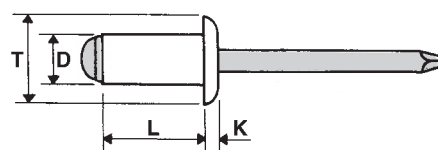

RIVETTI A STRAPPO RULLATI

GROOVED RIVETS

AL-RUL - TT

TESTA TONDA DOME HEAD

boccola / body

alluminio / aluminium

mandrino / mandrel

acciaio zincato / steel zinc plated

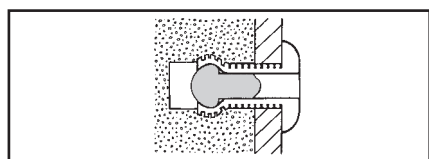
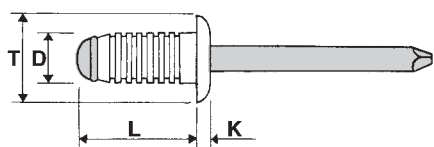

D	L	T	K	∅ foro/hole		CODICE code		
3,2	10	6	1,4	3,4	MAX 6 MAX 10	ALRUL3210TT	930 N	525 N
	14					ALRUL3214TT		
4,0	8	8	1,7	4,3	MAX 4 MAX 6 MAX 8 MAX 12	ALRUL4008TT	1410 N	885 N
	10					ALRUL4010TT		
	12					ALRUL4012TT		
	16					ALRUL4016TT		
4,8	8	9,5	2,0	5,1	MAX 4 MAX 6 MAX 7 MAX 8 MAX 10 MAX 12 MAX 14 MAX 16 MAX 21 MAX 26	ALRUL4808TT	1575 N	1185 N
	10					ALRUL4810TT		
	11					ALRUL4811TT		
	12					ALRUL4812TT		
	14					ALRUL4814TT		
	16					ALRUL4816TT		
	18					ALRUL4818TT		
	20					ALRUL4820TT		
	25					ALRUL4825TT		
	30					ALRUL4830TT		

FA - TT

TESTA TONDA DOME HEAD

boccola / body

alluminio / aluminium

mandrino / mandrel

acciaio zincato / steel zinc plated

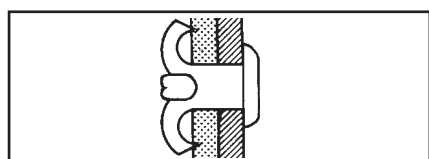
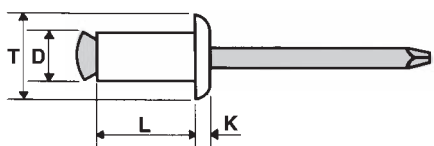

D	L	T	K	∅ foro/hole		CODICE code		
3,2	8	6	0,8	3,5	0,5 - 1 1 - 3 3 - 5	FA3208TT	700 N	765 N
	10					FA3210TT		
	12					FA3212TT		
4,0	10	8	1,2	4,3	1,5 - 5 3 - 6 6 - 10 10 - 14 14 - 18 18 - 24	FA4010TT	1150 N	1260 N
	12					FA4012TT		
	16					FA4016TT		
	20					FA4020TT		
	24					FA4024TT		
	30					FA4030TT		
4,8	10	10	1,3	5,2	0,5 - 4 2 - 6 4 - 8 5 - 10 10 - 14 14 - 18 18 - 22 22 - 27 27 - 32 32 - 37 37 - 42	FA4810TT	2400 N	2200 N
	12					FA4812TT		
	14					FA4814TT		
	16					FA4816TT		
	20					FA4820TT		
	24					FA4824TT		
	30					FA4830TT		
	35					FA4835TT		
	40					FA4840TT		
	45					FA4845TT		
	50					FA4850TT		

RIVETTI PER MATERIE PLASTICHE

BLIND RIVETS FOR PLASTIC

1

18.34

D	L	T	K	∅ foro/hole		CODICE code		
4,0	13,6 18,8	8	1,4	4,3	1 - 3 3 - 7	ALSOF4014TT ALSOF4019TT	800 N	500 N
4,8	15,3 20,5 24,5	9,6	1,6	5,1	1 - 3 3 - 9 5 - 12	ALSOF4815TT ALSOF4821TT ALSOF4825TT	1100 N	900 N

AL-SOF - TT

TESTA TONDA DOME HEAD

boccola / body

alluminio / aluminium

mandrino / mandrel

alluminio / aluminium

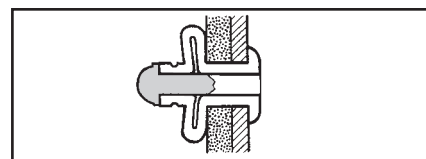
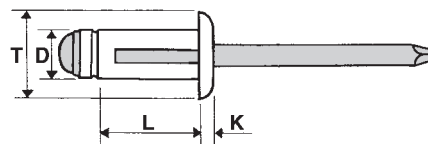

D	L	T	K	∅ foro/hole		CODICE code		
5,2	17,5 22,2 25,4 28,6 31,8	11,7	2,2	5,3	0,5 - 4,8 4,8 - 9,5 7,9 - 12,7 11,1 - 15,9 14,3 - 19,1	ALSOF5218TTO ALSOF5222TTO ALSOF5225TTO ALSOF5229TTO ALSOF5232TTO	3200 N	2000 N

AL-SOF - TTO

TESTA TONDA DOME HEAD

boccola / body

alluminio / aluminium

mandrino / mandrel

alluminio / aluminium

La rondella in neoprene garantisce la tenuta stagna

Good seal thanks to neoprene washer

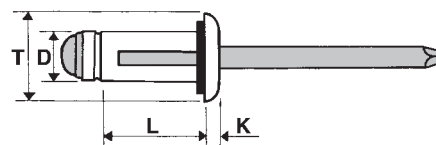

RIVETTI A STRAPPO TENUTA STAGNA

SEALED BLIND RIVETS

TST-AL - TT

TESTA TONDA DOME HEAD





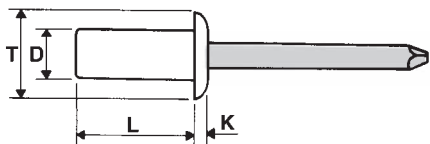

boccola / body

alluminio / aluminium

mandrino / mandrel

acciaio / steel



D	L	T	K	∅ foro/hole		CODICE code		
3,2	6,5	6	1,4	3,3		TSTAL3206TT	1250 N	1070 N
	8					TSTAL3208TT		
	9,5					TSTAL3210TT		
	10,7					TSTAL3211TT		
	12,5					TSTAL3212TT		
4,0	8	8	1,7	4,1		TSTAL4008TT	2240 N	1700 N
	9,5					TSTAL4010TT		
	11					TSTAL4011TT		
	12,5					TSTAL4012TT		
	15					TSTAL4014TT		
4,8	8	9	2,0	4,9		TSTAL4808TT	3100 N	2200 N
	9,5					TSTAL4810TT		
	11					TSTAL4811TT		
	12,5					TSTAL4812TT		
	14					TSTAL4814TT		
	16					TSTAL4816TT		
	18					TSTAL4818TT		
	21					TSTAL4821TT		
	25					TSTAL4825TT		
6,4	12,5	12,7	2,5	6,5		TSTAL6413TT	4900 N	3950 N
	16					TSTAL6416TT		

TST-AL - TS

TESTA SVASATA COUNTERSUNK HEAD



boccola / body

alluminio / aluminium

mandrino / mandrel

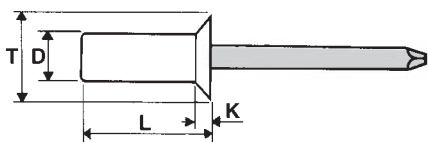
acciaio / steel









3,2	7,5	6	-	3,3		TSTAL3207TS	1250 N	1070 N
	9					TSTAL3209TS		
	10,5					TSTAL3211TS		
	12					TSTAL3212TS		
	13					TSTAL3213TS		
4,0	9,5	8	-	4,1		TSTAL4009TS	2240 N	1700 N
	11					TSTAL4011TS		
	12,5					TSTAL4013TS		
	14					TSTAL4014TS		
4,8	9,5	9,5	-	4,9		TSTAL4810TS	3100 N	2200 N
	11					TSTAL4811TS		
	12,5					TSTAL4812TS		
	14					TSTAL4814TS		
	15,5					TSTAL4816TS		
	17					TSTAL4817TS		
	19					TSTAL4819TS		
	24					TSTAL4824TS		

RIVETTI A STRAPPO TENUTA STAGNA

SEALED BLIND RIVETS

1

20.34

D	L	T	K	∅ foro/hole		CODICE code		
3,2	6,5	6	1,4	3,3		TSTALX3207TT	1250 N	1070 N
	8					TSTALX3208TT		
	9,5					TSTALX3210TT		
	10,7					TSTALX3211TT		
	12,5					TSTALX3213TT		
4,0	8	8	1,7	4,1		TSTALX4008TT	2240 N	1700 N
	9,5					TSTALX4010TT		
	11					TSTALX4011TT		
	12,5					TSTALX4013TT		
	15					TSTALX4015TT		
4,8	8	9	2,0	4,9		TSTALX4808TT	3100 N	2200 N
	9,5					TSTALX4810TT		
	11					TSTALX4811TT		
	12,5					TSTALX4813TT		
	14					TSTALX4814TT		
	16					TSTALX4816TT		
	18					TSTALX4818TT		
	21					TSTALX4821TT		
	25					TSTALX4825TT		

TST-ALX - TT

TESTA TONDA DOME HEAD



boccola / body

alluminio / aluminium

mandrino / mandrel

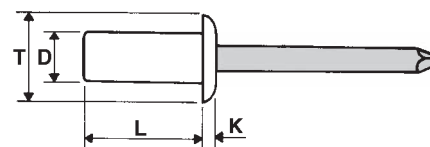
acciaio inox A2 / stainless steel A2



3,2	6	6	1	3,3		TSTAOZ3206TT	2200 N	1600 N
	8					TSTAOZ3208TT		
	9,5					TSTAOZ3209TT		
	12					TSTAOZ3212TT		
4,0	6	8	1,4	4,1		TSTAOZ4006TT	2500 N	2300 N
	8					TSTAOZ4008TT		
	10					TSTAOZ4010TT		
	12					TSTAOZ4012TT		
	15					TSTAOZ4015TT		
4,8	8	9,5	1,7	4,9		TSTAOZ4808TT	3800 N	2900 N
	9,5					TSTAOZ4809TT		
	12					TSTAOZ4812TT		
	16					TSTAOZ4816TT		

TST-AOZ - TT

TESTA TONDA DOME HEAD

boccola / body

acciaio zincato / steel zinc plated

mandrino / mandrel

acciaio zincato / steel zinc plated

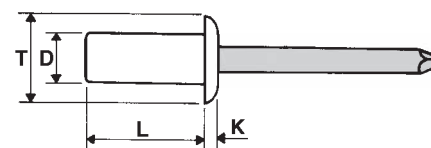

RIVETTI A STRAPPO TENUTA STAGNA

SEALED BLIND RIVETS

TST-CU - TT

TESTA TONDA DOME HEAD

boccola / body
rame / copper

mandrino / mandrel
acciaio / steel zinc plated

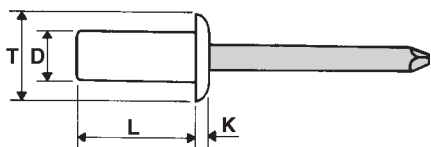

D	L	T	K	∅ foro/hole		CODICE code		
3,2	6	6	1,4	3,3	1 - 1,6 1,6 - 3,2 3,2 - 4,8 4,8 - 8	TSTCU3206TT	1420 N	1020 N
	7,5					TSTCU3207TT		
	9					TSTCU3209TT		
	12					TSTCU3212TT		
4,0	8	8	1,7	4,1	0,5 - 3,5 3 - 4,8 4,8 - 8	TSTCU4008TT	2260 N	1550 N
	9,5					TSTCU4009TT		
	12,5					TSTCU4012TT		
4,8	8,5	9,5	2,0	5,0	2 - 3,2 3,2 - 6,4	TSTCU4808TT	3110 N	2130 N
	11,5					TSTCU4811TT		

TST-CUX - TT

TESTA TONDA DOME HEAD

boccola / body
rame / copper

mandrino / mandrel
acciaio inox A2 / stainless steel A2

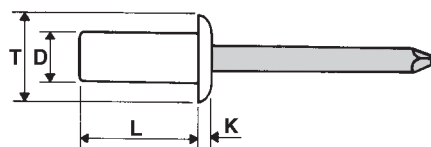



3,2	6	6	1,4	3,3	1 - 1,6 1,6 - 3,2 3,2 - 4,8 4,8 - 8	TSTCUX3206TT	1300 N	850 N
	7,5					TSTCUX3207TT		
	9					TSTCUX3209TT		
	12					TSTCUX3212TT		
4,0	8	8	1,7	4,1	0,5 - 3,5 3 - 4,8	TSTCUX4008TT	2000 N	1350 N
	9,5					TSTCUX4009TT		

RIVETTI A STRAPPO TENUTA STAGNA

SEALED BLIND RIVETS

1

22.34

D	L	T	K	∅ foro/hole		CODICE code		
3,2	6 8 9,5 12	6	1,4	3,3	0,5 - 1,5 1,5 - 3 3 - 5 5 - 7	TSTIX3206TT TSTIX3208TT TSTIX3210TT TSTIX3212TT	2500 N	2000 N
4,0	6 8 10 12 15	8	1,7	4,1	0,5 - 1,5 1,5 - 3 3 - 5 5 - 6,5 6,5 - 10,5	TSTIX4006TT TSTIX4008TT TSTIX4010TT TSTIX4012TT TSTIX4015TT	4000 N	3000 N
4,8	8 9,5 12 16 20	9,5	2	4,9	1 - 3 3 - 4,5 4,5 - 6 6 - 10,5 10,5 - 14	TSTIX4808TT TSTIX4810TT TSTIX4812TT TSTIX4816TT TSTIX4820TT	5500 N	4500 N
6,4	14 15,5 20	12,5	-	6,5	3,5 - 6,5 6,5 - 8 8 - 12,8	TSTIX6414TT TSTIX6415TT TSTIX6420TT	8700 N	6800 N

TST-IX - TT

TESTA TONDA DOME HEAD

boccola / body

**acciaio inox 304 / stainless
steel 304**

mandrino / mandrel

**acciaio inox 420 / stainless
steel 420**

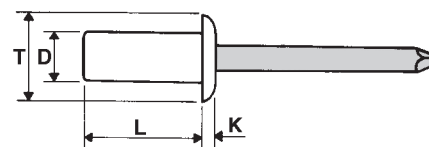

RIVETTI A STRAPPO MULTIFIX

MULTIGRIP BLIND RIVETS

MX-AL - TT

TESTA TONDA DOME HEAD

boccola / body

alluminio Mg. 2,5 / aluminium Mg. 2,5

mandrino / mandrel

acciaio zincato / steel zinc plated

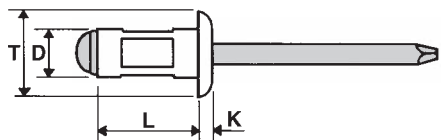

D	L	T	K	∅ foro/hole		CODICE code		
3,0	6	6	1,4	3,1		MXAL3006TT	810 N	620 N
	8					MXAL3008TT		
	10					MXAL3010TT		
	12					MXAL3012TT		
3,2	6	6	1,4	3,3		MXAL3206TT	980 N	760 N
	8					MXAL3208TT		
	9,5					MXAL3210TT		
	11					MXAL3211TT		
	12,5					MXAL3212TT		
	14					MXAL3214TT		
	16					MXAL3216TT		
4,0	8	8	1,7	4,1		MXAL4008TT	1600 N	1200 N
	9,5					MXAL4010TT		
	12,5					MXAL4012TT		
	17					MXAL4017TT		
	18					MXAL4018TT		
	20					MXAL4020TT		
						MXAL4020TT		
4,8	11	9,5	2,0	4,9		MXAL4811TT	2350 N	1690 N
	12,5					MXAL4813TT		
	15					MXAL4815TT		
	17					MXAL4817TT		
	20					MXAL4820TT		
	24,8					MXAL4825TT		
	27					MXAL4827TT		
	30					MXAL4830TT		
						MXAL4830TT		

MX-AL - TS

TESTA SVASATA COUNTERSUNK HEAD

boccola / body

alluminio Mg. 2,5 / aluminium Mg. 2,5

mandrino / mandrel

acciaio zincato / steel zinc plated

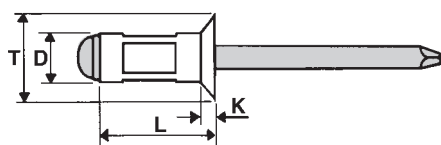

3,2	8	6	-	3,3		MXAL3208TS	980 N	760 N
	9,5					MXAL3210TS		
	12,5					MXAL3212TS		
	14					MXAL3214TS		
	16					MXAL3216TS		
4,0	8	8	-	4,1		MXAL4008TS	1600 N	1200 N
	9,5					MXAL4010TS		
	12,5					MXAL4012TS		
	14					MXAL4014TS		
	17					MXAL4017TS		
	18					MXAL4018TS		
	20					MXAL4020TS		
4,8	10	9,5	-	4,9		MXAL4810TS	2350 N	1690 N
	12,5					MXAL4812TS		
	15					MXAL4815TS		
	17					MXAL4817TS		
	20					MXAL4820TS		
	22					MXAL4822TS		
	24					MXAL4824TS		
	27					MXAL4827TS		
	30					MXAL4830TS		
						MXAL4830TS		

RIVETTI A STRAPPO MULTIFIX

MULTIGRIP BLIND RIVETS

1

24.34

D	L	T	K	∅ foro/hole		CODICE code		
3,2	8 9,5 12,5 14 16	9,5	2,0	3,3		MXAL3208TL MXAL3210TL MXAL3212TL MXAL3214TL MXAL3216TL	980 N	760 N
4,0	9,5 12,5 14 17 18 20	12,0	2,5	4,1		1 - 6 MXAL4010TL 4 - 9 MXAL4012TL 5,5 - 10,5 MXAL4014TL 8,5 - 13,5 MXAL4017TL 9,5 - 15,5 MXAL4018TL 11,5 - 16,5 MXAL4020TL	1600 N	1200 N
4,8	10 12,5 15 17 20	14	2,5	4,9		1 - 5 MXAL4810TL 3 - 7,5 MXAL4812TL 5 - 10 MXAL4815TL 7 - 12 MXAL4817TL 10 - 15 MXAL4820TL	2350 N	1690 N

MX-AL - TL

TESTA LARGA
LARGE HEAD

boccola / body

alluminio Mg. 2,5 / aluminium
Mg. 2,5

mandrino / mandrel

acciaio zincato / steel zinc plated

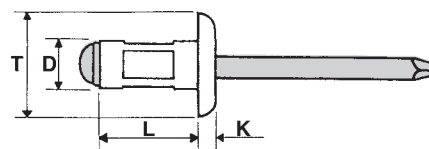

4,8	10 12,5 15 17 20 24,8 27	16	2,5	4,9		1 - 5 MXAL4810TXL 3 - 7,5 MXAL4812TXL 5 - 10 MXAL4815TXL 7 - 12 MXAL4817TXL 10 - 15 MXAL4820TXL 14,5 - 19,5 MXAL4824TXL 15 - 23 MXAL4827TXL	2350 N	1690 N
-----	--	----	-----	-----	--	--	-----------	-----------

MX-AL - TXL

TESTA EXTRA LARGA
EXTRA LARGE HEAD

boccola / body

alluminio Mg. 2,5 / aluminium
Mg. 2,5

mandrino / mandrel

acciaio zincato / steel zinc plated

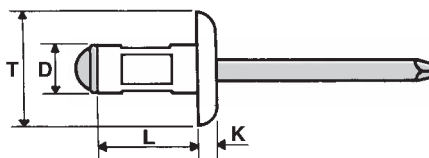

RIVETTI A STRAPPO MULTIFIX

MULTIGRIP BLIND RIVETS

MX-ALX - TT

TESTA TONDA DOME HEAD

boccola / body

alluminio Mg. 2,5 / aluminium
Mg. 2,5

mandrino / mandrel

acciaio inox A2 / stainless
steel A2

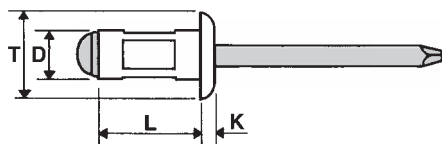

D	L	T	K	Ø foro/hole		CODICE code		
3,0	8	6	1,4	3,1		MXALX3008TT	810 N	620 N
	9,5					MXALX3010TT		
	12,5					MXALX3013TT		
3,2	8	6	1,4	3,3		MXALX3208TT	980 N	760 N
	9,5					MXALX3210TT		
	12,5					MXALX3213TT		
4,0	9,5	8	1,7	4,1		MXALX4009TT	1600 N	1200 N
	12,5					MXALX4012TT		
	16,9					MXALX4016TT		
4,8	10	9,5	2	5,0		MXALX4810TT	2350 N	1690 N
	12,5					MXALX4813TT		
	15					MXALX4815TT		
	16,9					MXALX4816TT		
	20					MXALX4820TT		
	24,8					MXALX4824TT		

MX-AOZ - TT

TESTA TONDA DOME HEAD

boccola / body

acciaio zincato / steel zinc plated

mandrino / mandrel

acciaio zincato / steel zinc plated

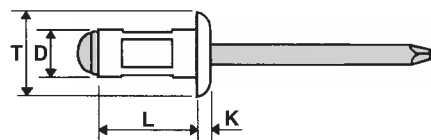

D	L	T	K	Ø foro/hole		CODICE code		
3,2	7	7,2	1	3,3		MXAOZ3207TT	1700 N	1500 N
	9					MXAOZ3209TT		
	11					MXAOZ3211TT		
4,0	10,8	8,1	1,2	4,1		MXAOZ4011TT	2350 N	1955 N
	12,5					MXAOZ4013TT		
	15					MXAOZ4015TT		
4,8	10,2	9,8	1,75	4,9		MXAOZ4810TT	3600 N	3335 N
	12,7					MXAOZ4813TT		
	13,5					MXAOZ4814TT		
	17,5					MXAOZ4818TT		



RIVETTI STRUTTURALI AD ALTA TENUTA

STRUCTURAL RIVETS

1

26.34

- Elevata resistenza alle vibrazioni e buona tenuta ermetica
- *High resistance to vibrations and good seal*

D	L	T	K	F	∅		CODICE code		
4,8	10 14	9,6	2,4	18,3 25,5	4,9	1,6 - 6,4 1,6 - 11,1	MFX4810TT MFX4814TT	4800 N	6000 N
6,4	14 20	13	3,1	25,0 35,0	6,6	2 - 9,5 2 - 15,9	MFX6414TT MFX6420TT	8240 N	10690 N

MFX - TT

TESTA TONDA DOME HEAD

boccola / body

acciaio zincato / steel zinc plated

mandrino / mandrel

acciaio zincato / steel zinc plated

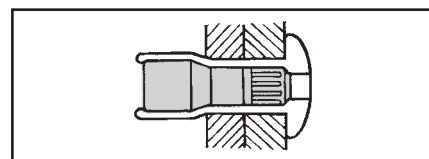
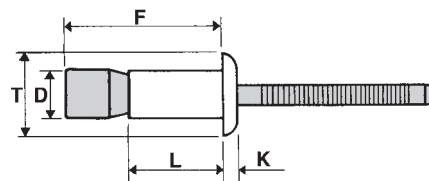

4,8	13 16	8,5	1,9	20 26	4,9	3,6 - 7,9 3,6 - 12,7	MFX4813TS MFX4816TS	4800 N	6000 N
6,4	17 22	10,2	2,2	27	6,6	5 - 11,1 5 - 17,5	MFX6417TS MFX6422TS	8240 N	10690 N

MFX - TS

TESTA SVASATA COUNTERSUNK HEAD

boccola / body

acciaio zincato / steel zinc plated

mandrino / mandrel

acciaio zincato / steel zinc plated

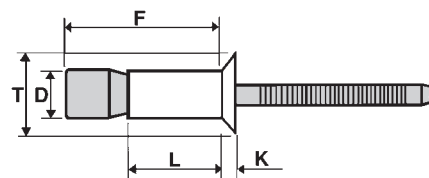

RIVETTI STRUTTURALI AD ALTA TENUTA

STRUCTURAL RIVETS

- Elevata resistenza alle vibrazioni e buona tenuta ermetica
- High resistance to vibrations and good seal

MFX - TT AL

TESTA TONDA DOME HEAD

boccola / body

alluminio / aluminium

mandrino / mandrel

alluminio / aluminium

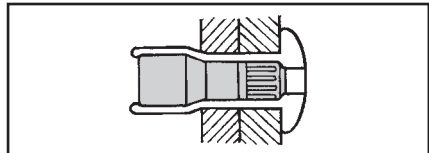
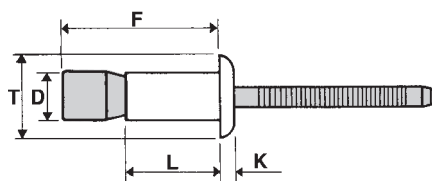

D	L	T	K	F	∅		CODICE code		
4,8	10,9 14,2	10	2,0	18,3 24	5,0	1,6 - 6,9 1,6 - 11,1	MFX4810TTAL MFX4814TTAL	2200 N	3000 N
6,4	14,6 19,7	13	2,5	24,5 34,7	6,6	2 - 9,5 2 - 15,9	MFX6414TTAL MFX6420TTAL	4200 N	6000 N

MFX - TS AL

TESTA SVASATA COUNTERSUNK HEAD

boccola / body

alluminio / aluminium

mandrino / mandrel

alluminio / aluminium

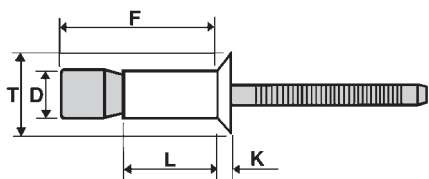



4,8	12,7 15,9	8,25	2	20 26,2	5,0	3,2 - 8,4 1,6 - 11,1	MFX4813TSAL MFX4816TSAL	2100 N	2800 N
6,4	17,2	10	2,2	27,2	6,6	3,2 - 12,1	MFX6417TSAL	4200 N	6000 N

RIVETTI STRUTTURALI AD ALTA TENUTA

STRUCTURAL RIVETS

- Elevata resistenza alle vibrazioni e buona tenuta ermetica
- *High resistance to vibrations and good seal*



D	L	T	K	F	∅		CODICE code		
4,8	10 14	9,6	2,4	18 25	4,9	1,6 - 6,4 1,6 - 11,1	MFX4810TTIX MFX4814TTIX	5700 N	6700 N
6,4	14 20	13	3,1	24 33	6,6	2 - 9,5 2 - 15,9	MFX6414TTIX MFX6420TTIX	8700 N	10700 N

MFX - TT IX

TESTA TONDA DOME HEAD

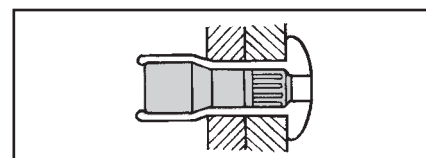
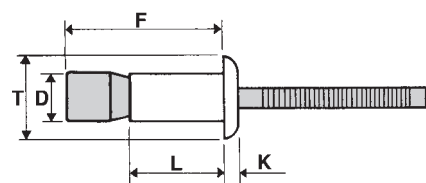
boccola / *body*
acciaio inox 304 / *stainless steel 304*
mandrino / *mandrel*
acciaio inox 304 / *stainless steel 304*



D	L	T	K	F	∅		CODICE code		
4,8	12 16	8,5	1,9	18 25	4,9	3,6 - 7,9 3,6 - 12,7	MFX4812TSIX MFX4816TSIX	5700 N	6700 N
6,4	16 22	10,2	2,2	18 25	6,6	5 - 11,1 5 - 17,5	MFX6416TSIX MFX6422TSIX	8700 N	10700 N

MFX - TS IX

TESTA SVASATA COUNTERSUNK HEAD

boccola / *body*
acciaio inox 304 / *stainless steel 304*
mandrino / *mandrel*
acciaio inox 304 / *stainless steel 304*

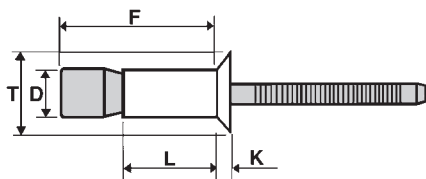

RIVETTI STRUTTURALI AD ALTA TENUTA

STRUCTURAL RIVETS

- La controtesta più larga garantisce maggiore tenuta e non deforma i materiali a lastra sottile
For thin sheet applications
- E' resistente all'acqua ed alle vibrazioni
Good resistance to vibrations and good seal

MBX - TT

TESTA TONDA DOME HEAD



boccola / body

acciaio zincato / steel zinc plated

mandrino / mandrel

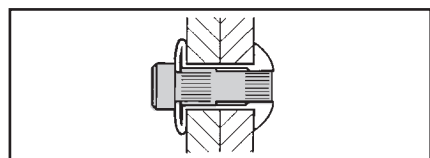
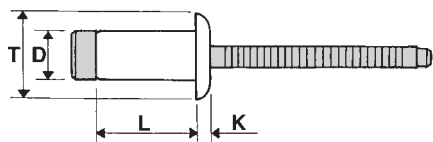
acciaio zincato / steel zinc plated





D	L	T	K	∅		CODICE code		
							N	N
3,2	7	6,5	1,4	3,3	1 - 3	MBX3207TT	1300	1600
	9				3 - 5	MBX3209TT		
	11				5 - 7	MBX3211TT		
4,0	7,5	8	1,7	4,1	1 - 3	MBX4008TT	2800	3500
	9,5				3 - 5	MBX4010TT		
	12,5				5 - 7	MBX4012TT		
4,8	10	9,5	2	4,9	1,5 - 3,5	MBX4810TT	3800	4200
	12				3,5 - 6	MBX4812TT		
	14				6 - 8,5	MBX4814TT		
6,0	10	12	1,8	6,1	1,5 - 4	MBX6010TT	5400	4200
	13				3 - 6	MBX6013TT		5400
	16				6 - 9	MBX6016TT		8500
	19				9 - 12	MBX6019TT		8500
6,4	9	13	3	6,6	1,5 - 3,5	MBX6409TT	7100	8900
	10				2,8 - 4,8	MBX6410TT		10200
	11				3,4 - 5,4	MBX6411TT		10600
	12				4,8 - 6,8	MBX6412TT		10600
	14				6,8 - 8,8	MBX6414TT		12700
	16				8,8 - 10,8	MBX6416TT		13600
	18				10,8 - 12,8	MBX6418TT		13600

RIVETTI STRUTTURALI AD ALTA TENUTA

STRUCTURAL RIVETS

- La controtesta più larga garantisce maggiore tenuta e non deforma i materiali a lastra sottile
For thin sheet applications
- E' resistente all'acqua ed alle vibrazioni
Good resistance to vibrations and good seal

D	L	T	K	∅		CODICE code		
3,2	6,6	6,5	1,4	3,3	1 - 3	MBX3207TTIX	2000	1600
	9,2				3 - 5	MBX3209TTIX		
	11,5				5 - 7	MBX3211TTIX		
4,0	8	8	1,7	4,1	1 - 3	MBX4008TTIX	3800	4200
	10				3 - 5	MBX4010TTIX		
	12				5 - 7	MBX4012TTIX		
4,8	10	9,5	2	4,9	1,5 - 3,5	MBX4810TTIX	5000	5500
	12				3,5 - 6	MBX4812TTIX		
	14,3				6 - 8,5	MBX4814TTIX		
6,4	9	13	3	6,6	1,5 - 3,5	MBX6409TTIX	8000	10000
	10				2,8 - 4,8	MBX6410TTIX		
	11				3,4 - 5,4	MBX6411TTIX		
	12				4,8 - 6,8	MBX6412TTIX		
	14				6,8 - 8,8	MBX6414TTIX		
	16				8,8 - 10,8	MBX6416TTIX		
	18				10,8 - 12,8	MBX6418TTIX		

MBX - TT IX

TESTA TONDA DOME HEAD

boccola / body
**acciaio inox A2 /
stainless steel A2**
mandrino / mandrel
**acciaio inox A2 /
stainless steel A2**

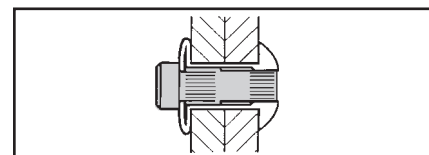
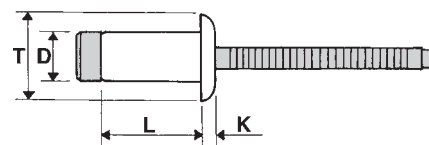

RIVETTATRICI MANUALI PER RIVETTI A STRAPPO

HAND TOOLS FOR BLIND RIVETS

ATTREZZATURE TOOLS



150

UTILIZZO
CAPACITY ø 2,4 - 5 mm.

LUNGHEZZA
LENGHT 255 mm.

EQUIPAGGIAMENTO
EQUIPMENT
UGELLI
NOSE PIECES ø 2,4 - 5 mm.

MATERIALE DEL CORPO
BODY MATERIAL
ALLUMINIO / ALUMINIUM

MATERIALE DELLA LEVA
LEVER MATERIAL
FERRO / STEEL

PESO
WEIGHT 0,7 Kg.

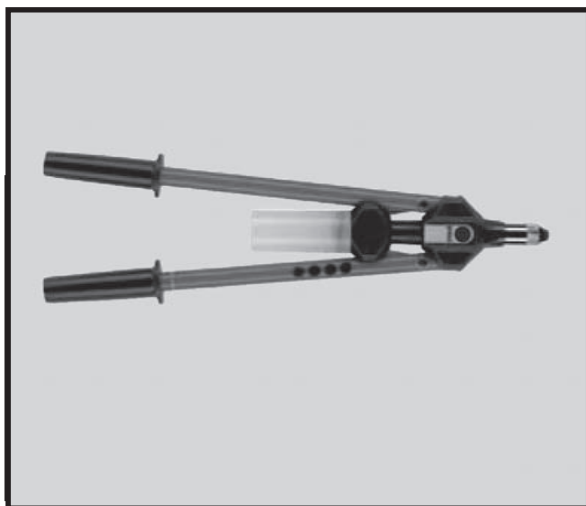

260

UTILIZZO
CAPACITY ø 3 - 6,4 mm.

LUNGHEZZA
LENGHT 500 mm.

EQUIPAGGIAMENTO
EQUIPMENT
UGELLI
NOSE PIECES ø 3 - 6,4 mm.

MATERIALE DEL CORPO
BODY MATERIAL
PLASTICA CON PARTI IN ACCIAIO
PLASTIC WITH STEEL PARTS

MATERIALE DELLA LEVA
LEVER MATERIAL
FERRO / STEEL

PESO
WEIGHT 1,8 Kg.

RIVETTATRICE A BATTERIA

BLIND RIVET BATTERY TOOL



DATI TECNICI:

TECHNICAL SPECIFICATION:

alluminio,rame <i>aluminium, copper:</i>	2,8 - 3,2 - 4,0 - 4,8 - 5,2 mm
acciaio,inox <i>steel, stainless steel:</i>	2,8 - 3,2 - 4,0 - 4,8 mm
tensione della batteria <i>battery power:</i>	14,4 V (Li-ion) 3.0 Ah
forza di trazione <i>traction power:</i>	8500 N
corsa <i>stroke:</i>	20 mm
peso con batteria <i>total weight:</i>	2,1 Kg
caricabatteria intelligente <i>fast charger:</i>	14.4 V VDC
tensione in entrata <i>power surce:</i>	220V VAC, 50 Hz
tensione in uscita <i>charging voltage:</i>	14.4 V VDC
tempo di ricarica <i>charging time:</i>	60 min. at 20°

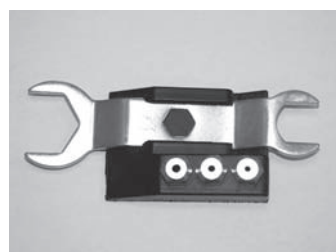

ACCESSORI E RICAMBI IN DOTAZIONE:

SPARE PARTS:

Seconda Batteria in dotazione Li-Ion

Second Battery 14.4 V, 3 Ah

Caricabatteria intelligente

Charger intelligent

Ugelli

2,8 mm - 3,2 mm

Nose pieces

4,0 mm - 4,8 mm



ACCESSORI E RICAMBI A RICHIESTA:

SPARE PART ON REQUEST

Morsetti di ricambio

Jaws (2 pieces)

Spazzole di ricambio (2 pzi)

Brushes (2 pieces)

Corpo in nylon dx

Housing dx

Corpo in nylon sx

Housing sx

Prolunga

Extension



RIVETTATRICI PNEUMATICHE PER RIVETTI A STRAPPO

PNEUMATIC TOOLS FOR BLIND RIVETS

ATTREZZATURE TOOLS



AP 1	UTILIZZO CAPACITY	ø 2,4 - 5 mm.
	PRESSIONE DI UTILIZZO PRESSURE REQUIRED	5 - 7 BAR
	DIMENSIONI DIMENSIONS	272 x 264mm.
	EQUIPAGGIAMENTO EQUIPMENT	
	UGELLI NOSE PIECES	ø 2,4-5 mm
	CORSA STROKE	17 mm.
	FORZA (6 BAR) TRACTION POWER (6 BAR)	7,3 KN
	PESO WEIGHT	1.25 Kg.



AP 2	UTILIZZO CAPACITY	ø 4 - 6,4 mm.
	PRESSIONE DI UTILIZZO PRESSURE REQUIRED	5-7 BAR
	DIMENSIONI DIMENSIONS	272 x 275mm
	EQUIPAGGIAMENTO EQUIPMENT	
	UGELLI NOSE PIECES	ø 4 - 6,4 mm
	CORSA STROKE	21 mm.
	FORZA (6 BAR) TRACTION POWER (6 BAR)	12,5 KN
	PESO WEIGHT	1.65 Kg.



AP 3	UTILIZZO CAPACITY	ø 4,0 - 6,4 mm.
	RIVETTI STRUTTURALI STRUCTURAL RIVETS	ø 4,8 - 6,4 mm
	PRESSIONE DI UTILIZZO PRESSURE REQUIRED	5-7 BAR
	DIMENSIONI DIMENSIONS	292 x 290 x 125mm
	EQUIPAGGIAMENTO EQUIPMENT	
	UGELLI NOSE PIECES	ø 4,8 - 6,4 mm
	CORSA STROKE	25 mm.
	FORZA (6 BAR) TRACTION POWER (6 BAR)	16 KN
	PESO WEIGHT	1.8 Kg.

RIVETTATRICI PNEUMATICHE PER RIVETTI A STRAPPO

PNEUMATIC TOOLS FOR BLIND RIVETS

ATTREZZATURE TOOLS



BZ 103	UTILIZZO CAPACITY	ø 2,4 - 5 mm.
	PRESSIONE DI UTILIZZO PRESSURE REQUIRED	5 - 7 BAR
	DIMENSIONI DIMENSIONS	305 x 310 mm.
	EQUIPAGGIAMENTO EQUIPMENT	
	UGELLI NOSE PIECES	ø 2,4-5 mm
	CORSA STROKE	18 mm.
	FORZA TRACTION POWER	11.750 N
	PESO WEIGHT	1,86 Kg.
	VIBRAZIONI VIBRATIONS	0,62 m/s ²



BZ 123	UTILIZZO CAPACITY	ø 4,0 - 6,4 mm.
	RIVETTI STRUTTURALI STRUCTURAL RIVETS	ø 4,8 - 6,4 mm
	PRESSIONE DI UTILIZZO PRESSURE REQUIRED	5-7 BAR
	DIMENSIONI DIMENSIONS	310 x 350 mm
	EQUIPAGGIAMENTO EQUIPMENT	
	UGELLI NOSE PIECES	ø 4 - 6,4 mm
	CORSA STROKE	25 mm.
	FORZA TRACTION POWER	17.730 N
	PESO WEIGHT	2,41 Kg.
	VIBRAZIONI VIBRATIONS	1,1 m/s ²